



Shoebox PC 3231

Fanless



Sans ventilateur



Processeur Intel du Celeron au Core I5



Windows ou Linux



Températures supportés -20 ~ 60°C

La gamme **Shoebox PC** regroupe une forte **puissance de calcul** dans un châssis minimisé, ce qui est particulièrement important pour une utilisation industrielle. Ces unités peuvent gérer l'ensemble de vos applications industrielles, (ERP, MES, GPAO, TRS, gestion de production, ...)

Les Shoebox PC offrent une **fiabilité** exceptionnelle grâce à leurs conception **sans ventilateur**, éliminant ainsi les risques de surchauffe et les problèmes de maintenance associés aux ventilateurs traditionnels.

Les Shoebox PC redéfinissent les normes en matière de puissance, de **design compact** et de **robustesse** pour répondre aux défis de l'industrie moderne, c'est une solution fiable et polyvalente pour toutes vos **applications industrielles**.



Vue arrière



Vue avant

SPÉCIFICATIONS

Processeur	Intel Bay Trail J1900, 4 coeurs, 2.0GHz
Mémoire	4 Go extensible à 8 Go
Stockage	SATA 2.5" et mSATA. 128, 256, 512 Go
Port série	11 x RS232 (en option 5 x RS485)
Port USB	1 x USB3.0 et 5 x USB2.0/1.1
Port Ethernet	2 x Realtek Gigabit Ethernet (RJ45)

Résolution	1920 x 1200 (Full HD)
OS	Windows 7, Windows 10, Windows 11, Ubuntu
Poids	1.5 Kg
Alimentation	+ 12 VDC
Châssis	Aluminium, Fanless (sans ventilateur)



HDMI et VGA



Connecteur pour déport bouton M/A



Bornier à vis pour câble d'alimentation électrique



Shoebox PC 3231

Fanless

Dimensions et encombrement

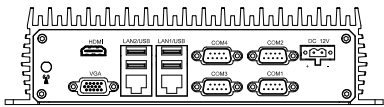
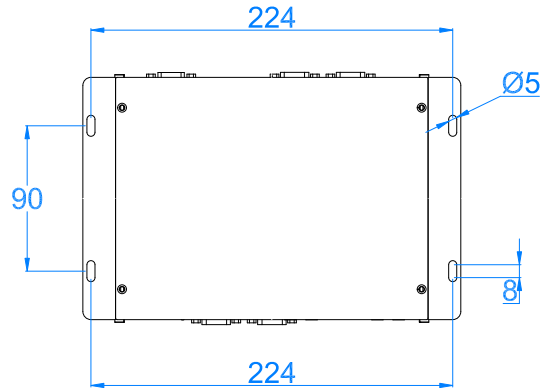
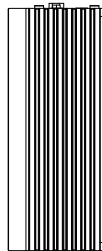
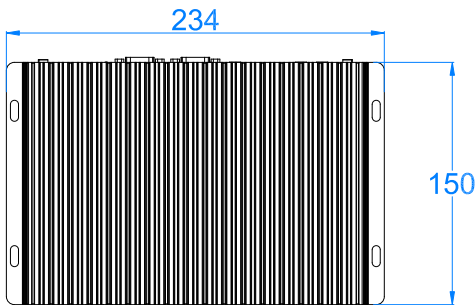
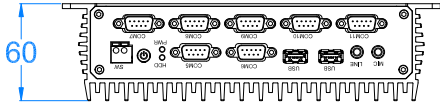

Vue bandeau connecteurs

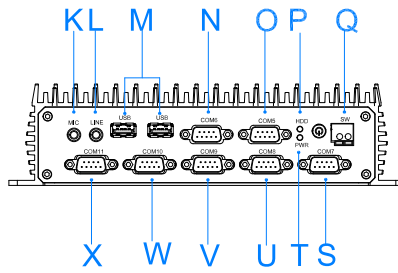
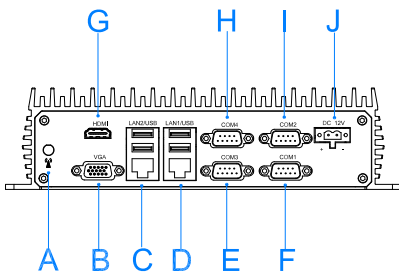

- A:ANT
- B:VGA
- C:LAN1/USB
- D:LAN2/USB
- E:COM3
- F:COM1
- G:HDMI
- H:COM4
- I:COM2
- J:DC IN 12V

- K:MIC
- L:LANE
- M:USB
- N:COM6
- O:COM5
- P:HDD
- Q:SW
- R:PWR
- S:COM7
- T:PWR
- U:COM8
- V:COM9
- W:COM10
- X:COM11

